

Standardausführung, mit vollem Durchgang.

Material	Messing vernickelt
Kugel	Messing verchromt
Kugeldichtung	PTFE
Spindelabdichtung	HNBR / EPDM / PTFE
	Dichtungspaket besteht aus 2 O-Ringen (HNBR / EPDM peroxidisch vernetzt) und einer Dichtscheibe (PTFE). Die zusätzliche PTFE-Dichtscheibe minimiert den Verschleiß bei häufiger Betätigung.
Hebel	Stahl, mit Kunststoffüberzug
Betriebstemperatur	-15 °C bis +90 °C
Einsatzbereich	Druckluft, Wasser, nicht giftige und nicht aggressive Gase, Heizungsanlagen, Landwirtschaft
Gewinde	G-Gewinde nach DIN EN ISO 228-1

Kugelhähne, mit schwarzem Stahlhebel, Standardausführung, Innen/Innengewinde

Artikel Nr.	Ident Nr.	Gewinde	DN	PN bar	A mm	B mm	L mm	E mm	F mm	Ø C mm	Ø D mm	Kv
330.02-S	103157	G 1/4	8	63	85,0	37,2	46,0	12,0	12,0	24,0	10,0	6
330.03-S	103158	G 3/8	10	63	85,0	37,2	50,0	12,0	12,0	24,0	10,0	8
330.04-S	103159	G 1/2	15	40	85,0	44,1	50,0	9,5	9,5	31,2	15,0	15
330.05-S	103160	G 3/4	20	40	105,0	48,4	58,0	10,5	10,5	39,4	20,0	28
330.06-S	103161	G 1	25	40	105,0	52,3	69,0	12,0	12,0	47,6	25,0	39
330.07-S	103162	G 1 1/4	32	40	130,0	63,1	80,0	13,5	13,5	59,5	32,0	84
330.08-S	103163	G 1 1/2	40	40	130,0	69,1	91,5	14,5	14,5	72,0	40,0	156
330.09-S	103164	G 2	50	40	165,0	83,4	109,0	16,5	16,5	87,4	50,0	243
330.10-S	103165	G 2 1/2	65	40	248,0	97,0	133,0	18,5	18,5	110,0	65,0	476
330.11-S	103166	G 3	80	40	248,0	108,0	156,0	18,5	18,5	134,0	80,0	770

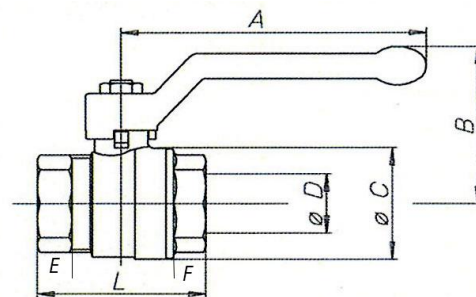

330.04-S

Kugelhähne, mit rotem Stahlhebel, Standardausführung, Innen/Innengewinde

Artikel Nr.	Ident Nr.	Gewinde	DN	PN bar	A mm	B mm	L mm	E mm	F mm	Ø C mm	Ø D mm	Kv
330.02-R	103167	G 1/4	8	63	85,0	37,2	46,0	12,0	12,0	24,0	10,0	6
330.03-R	103168	G 3/8	10	63	85,0	37,2	50,0	12,0	12,0	24,0	10,0	8
330.04-R	103169	G 1/2	15	40	85,0	44,1	50,0	9,5	9,5	31,2	15,0	15
330.05-R	103170	G 3/4	20	40	105,0	48,4	58,0	10,5	10,5	39,4	20,0	28
330.06-R	103171	G 1	25	40	105,0	52,3	69,0	12,0	12,0	47,6	25,0	39
330.07-R	103172	G 1 1/4	32	40	130,0	63,1	80,0	13,5	13,5	59,5	32,0	84
330.08-R	103173	G 1 1/2	40	40	130,0	69,1	91,5	14,5	14,5	72,0	40,0	156
330.09-R	103174	G 2	50	40	165,0	83,4	109,0	16,5	16,5	87,4	50,0	243
330.10-R	103175	G 2 1/2	65	40	248,0	97,0	133,0	18,5	18,5	110,0	65,0	476
330.11-R	103176	G 3	80	40	248,0	108,0	156,0	18,5	18,5	134,0	80,0	770



330.04-R

Kugelhähne, mit gelbem Stahlhebel, Standardausführung, Innen/Innengewinde

Artikel Nr.	Ident Nr.	Gewinde	DN	PN bar	A mm	B mm	L mm	E mm	F mm	Ø C mm	Ø D mm	Kv
330.02-B	103177	G 1/4	8	63	85,0	37,2	46,0	12,0	12,0	24,0	10,0	6
330.03-B	103178	G 3/8	10	63	85,0	37,2	50,0	12,0	12,0	24,0	10,0	8
330.04-B	103179	G 1/2	15	40	85,0	44,1	50,0	9,5	9,5	31,2	15,0	15
330.05-B	103180	G 3/4	20	40	105,0	48,4	58,0	10,5	10,5	39,4	20,0	28
330.06-B	103181	G 1	25	40	105,0	52,3	69,0	12,0	12,0	47,6	25,0	39
330.07-B	103182	G 1 1/4	32	40	130,0	63,1	80,0	13,5	13,5	59,5	32,0	84
330.08-B	103183	G 1 1/2	40	40	130,0	69,1	91,5	14,5	14,5	72,0	40,0	156
330.09-B	103184	G 2	50	40	165,0	83,4	109,0	16,5	16,5	87,4	50,0	243
330.10-B	103185	G 2 1/2	65	40	248,0	97,0	133,0	18,5	18,5	110,0	65,0	476
330.11-B	103186	G 3	80	40	248,0	108,0	156,0	18,5	18,5	134,0	80,0	770



330.04-B

Kugelhähne, mit gelbem Stahlhebel, Standardausführung, Innen/Innengewinde

Artikel Nr.	Ident Nr.	Gewinde	DN	PN bar	A mm	B mm	L mm	E mm	F mm	Ø C mm	Ø D mm	Kv
330.02-G	103187	G 1/4	8	63	85,0	37,2	46,0	12,0	12,0	24,0	10,0	6
330.03-G	103188	G 3/8	10	63	85,0	37,2	50,0	12,0	12,0	24,0	10,0	8
330.04-G	103189	G 1/2	15	40	85,0	44,1	50,0	9,5	9,5	31,2	15,0	15
330.05-G	103190	G 3/4	20	40	105,0	48,4	58,0	10,5	10,5	39,4	20,0	28
330.06-G	103191	G 1	25	40	105,0	52,3	69,0	12,0	12,0	47,6	25,0	39
330.07-G	103192	G 1 1/4	32	40	130,0	63,1	80,0	13,5	13,5	59,5	32,0	84
330.08-G	103193	G 1 1/2	40	40	130,0	69,1	91,5	14,5	14,5	72,0	40,0	156
330.09-G	103194	G 2	50	40	165,0	83,4	109,0	16,5	16,5	87,4	50,0	243



330.04-G

Kugelhähne, mit schwarzem Stahlhebel, Standardausführung, Innen/Außengewinde

Artikel Nr.	Ident Nr.	Gewinde	DN	PN bar	A mm	B mm	L mm	E mm	F mm	Ø C mm	Ø D mm	Kv
331.02-S	103195	G 1/4	8	63	85,0	37,2	51,0	9,4	12,0	24,0	10,0	6
331.03-S	103196	G 3/8	10	63	85,0	37,2	53,0	8,6	12,0	24,0	10,0	8
331.04-S	103197	G 1/2	15	40	85,0	44,1	59,8	9,5	9,5	31,2	15,0	15
331.05-S	103198	G 3/4	20	40	105,0	48,4	69,5	10,5	10,5	39,4	20,0	28
331.06-S	103199	G 1	25	40	105,0	52,3	78,8	12,0	12,0	47,6	25,0	39
331.07-S	103200	G 1 1/4	32	40	130,0	63,1	91,5	13,0	13,5	59,5	32,0	84
331.08-S	103201	G 1 1/2	40	40	130,0	69,1	104,0	14,5	14,5	72,0	40,0	156
331.09-S	103202	G 2	50	40	165,0	83,4	121,0	16,5	16,5	87,4	50,0	243



331.05-S

Kugelhähne, mit rotem Stahlhebel, Standardausführung, Innen/Außengewinde

Artikel Nr.	Ident Nr.	Gewinde	DN	PN bar	A mm	B mm	L mm	E mm	F mm	Ø C mm	Ø D mm	Kv
331.02-R	103203	G 1/4	8	63	85,0	37,2	51,0	9,4	12,0	24,0	10,0	6
331.03-R	103204	G 3/8	10	63	85,0	37,2	53,0	8,6	12,0	24,0	10,0	8
331.04-R	103205	G 1/2	15	40	85,0	44,1	59,8	9,5	9,5	31,2	15,0	15
331.05-R	103206	G 3/4	20	40	105,0	48,4	69,5	10,5	10,5	39,4	20,0	28
331.06-R	103207	G 1	25	40	105,0	52,3	78,8	12,0	12,0	47,6	25,0	39
331.07-R	103208	G 1 1/4	32	40	130,0	63,1	91,5	13,0	13,5	59,5	32,0	84
331.08-R	103209	G 1 1/2	40	40	130,0	69,1	104,0	14,5	14,5	72,0	40,0	156
331.09-R	103210	G 2	50	40	165,0	83,4	121,0	16,5	16,5	87,4	50,0	243



331.05-R

Kugelhähne, mit blauem Stahlhebel, Standardausführung, Innen/Außengewinde

Artikel Nr.	Ident Nr.	Gewinde	DN	PN bar	A mm	B mm	L mm	E mm	F mm	Ø C mm	Ø D mm	Kv
331.02-B	103211	G 1/4	8	63	85,0	37,2	51,0	9,4	12,0	24,0	10,0	6
331.03-B	103212	G 3/8	10	63	85,0	37,2	53,0	8,6	12,0	24,0	10,0	8
331.04-B	103213	G 1/2	15	40	85,0	44,1	59,8	9,5	9,5	31,2	15,0	15
331.05-B	103214	G 3/4	20	40	105,0	48,4	69,5	10,5	10,5	39,4	20,0	28
331.06-B	103215	G 1	25	40	105,0	52,3	78,8	12,0	12,0	47,6	25,0	39
331.07-B	103216	G 1 1/4	32	40	130,0	63,1	91,5	13,0	13,5	59,5	32,0	84
331.08-B	103217	G 1 1/2	40	40	130,0	69,1	104,0	14,5	14,5	72,0	40,0	156
331.09-B	103218	G 2	50	40	165,0	83,4	121,0	16,5	16,5	87,4	50,0	243



331.05-B

Kugelhähne, mit gelbem Stahlhebel, Standardausführung, Innen/Außengewinde

Artikel Nr.	Ident Nr.	Gewinde	DN	PN bar	A mm	B mm	L mm	E mm	F mm	Ø C mm	Ø D mm	Kv
331.02-G	103219	G 1/4	8	63	85,0	37,2	51,0	9,4	12,0	24,0	10,0	6
331.03-G	103220	G 3/8	10	63	85,0	37,2	53,0	8,6	12,0	24,0	10,0	8
331.04-G	103221	G 1/2	15	40	85,0	44,1	59,8	9,5	9,5	31,2	15,0	15
331.05-G	103222	G 3/4	20	40	105,0	48,4	69,5	10,5	10,5	39,4	20,0	28
331.06-G	103223	G 1	25	40	105,0	52,3	78,8	12,0	12,0	47,6	25,0	39
331.07-G	103224	G 1 1/4	32	40	130,0	63,1	91,5	13,0	13,5	59,5	32,0	84
331.08-G	103225	G 1 1/2	40	40	130,0	69,1	104,0	14,5	14,5	72,0	40,0	156
331.09-G	103226	G 2	50	40	165,0	83,4	121,0	16,5	16,5	87,4	50,0	243



331.05-G



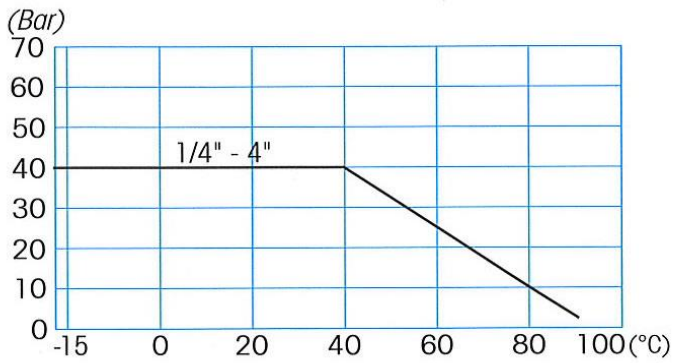



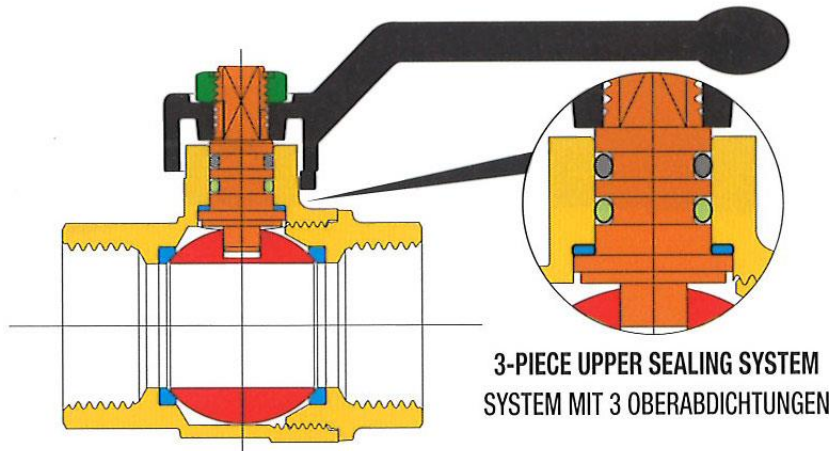

PRESSURE/TEMPERATURE DIAGRAM - DRUCK/TEMPERATURDIAGRAMM



SECTION / QUERSCHNITT



LIST OF COMPONENTS: description/materials/treatments TEILELISTE: Beschreibung / Werkstoffe / Behandlungen

Body and threaded end Gehäuse und Gewindemuffe		CW617N (Pb ≤ 2,2% DIN 50930T6)
Stem Betätigungsspindel		CW617N (Pb ≤ 2,2% DIN 50930T6)
Chromium pl. polished ball Blank verchromte Kugel		CW617N (Pb ≤ 2,2% DIN 50930T6)
Seats Dichtungen		PTFE
O-ring on the stem Oberer O-Ring Spindel		HNBR
O-ring under the stem Unterer O-Ring Spindel		EPDM PEROXIDE / PEROXID-EPDM
Operating device Betätigungselement		aluminium alloy / alu-Legierung
Fixing nut Befestigungsmutter		zinc plated steel / zinkstahl
Surface treatment Außenbehandlung	-	brilliant nickel-plating / glänzend vernickelte Oberfläche